



CLICK FRAMES & BROCHURE STANDS

Aluminium Frames	166
Menu Board	181
Steel Frames	185
Steel Frames - PVC Board	187
Light Box	188
Brochure Stand	193

Sagres

 Aluminium-Prospektständer. DIN A4 Prospekthalter aus Kunststoff oder Metall.

 Brochure stand for A4 brochures made with a heavy foot. The shelf is made of strong Polycarbonate or Steel.

 Support Porte brochure avec plateau A4 en aluminium ou plastique.

 Suporte em alumínio com bandeja de acrílico ou metálica para folhetos A4.

 Portafolletos realizado en aluminio con bandeja para folletos en tamaño A4, realizado en metacrilato o metálico.

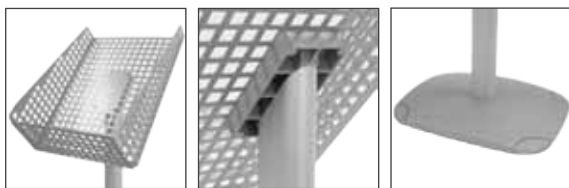

	QTY	N.W(kg)	G.W(kg)	C.B.M.	Size(mm)
Packing	1	2.9	3.6	0.032	295x120x910

10.473

Acrylic

42.50 €

	QTY	N.W(kg)	G.W(kg)	C.B.M.	Size(mm)
Packing	1	2.4	3.45	0.032	295x120x910

10.474

Steel

42.50 €



Bari

 Präsentationspult, Stahlblech DIN A4 Ablagefläche, grau lackiert.

 Catalogue display for A4 portrait brochures. Colour: Grey. Material: Steel.

 Support porte brochures en acier. Idéal pour brochures format A4.

 Estrutura em chapa de aço pintada de cinzento, ideal para catálogos formato A4. Material: aço.

 Portacatálogos realizado en chapa de acero y pintado en color gris. Ideal para la colocación de catálogos tamaño A4.

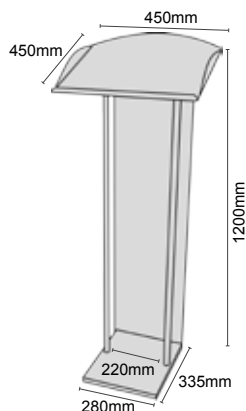

	QTY	N.W(kg)	G.W(kg)	C.B.M.	Size(mm)
Packing	1	8.6	11	0.312	500x500x1250

10.219

75.00 €



Vegas

Faltbarer Prospektständer aus verchromtem Stahl und Kunststoff. DIN A4 Format. Der perfekte Begleiter für Messeauftritte oder Produktpräsentationen. Höhe 1550mm.

Foldable brochure stand for A4 catalogs. Simple folding, becomes an important ally for fairs and shows. Made of plastic and chrome steel. Height: 1550mm.

Présentoir de catalogues pliable avec 4 divisions de dimension A4. Fabriqué en acier et plastique. Hauteur : 1550 mm.

Porta-catálogos desdobrável. Possui 4 bolsa A4 em acrílico. Ideal para feiras e demonstrações em pontos de venda. Material: aço e acrílico. Altura: 1550mm.

Expositor soporte para catálogos tamaño A4. De plegado ultrafácil, se convierte en un importante aliado para ferias y demostraciones en punto de venta. Fabricado en plástico y acero cromado. Altura: 1550mm.



1550mm

QTY: +50	
48.30 €/u	
QTY: +25	55.20 €/u
QTY: +10	62.10 €/u



10.048

Height: 1550mm

69.00 €



Sahagun

Faltbarer Prospektständer aus matt - grauem Aluminium und transparentem Kunststoff. Besteht aus 5 Ablagefächern. Gestell ist epoxybeschichtet.

Foldable brochure stand. Lightweight design in aluminium. Quick and easy to unfold. Includes aluminium suitcase. Available in acrylic or wood.

Porte-brochure portable fabriqué en acrylique transparent et aluminium gris mat. Comprend 5 compartiments pour brochures, poignée et base peinte en époxy.

Porta-catálogos portátil fabricado em acrílico transparente e alumínio cinzento baço. Possui 5 compartimentos para folhetos, Asa e base em metal pintada com epóxi.

Portafolletos portátil fabricado en metacrilato transparente y aluminio gris en acabado mate. Consta de 5 compartimentos para folletos, asa y base en chapa pintada epoxi.



1500mm



10.047

Height: 1500mm

105.00 €



Soubran

Faltbarer Prospektständer aus Stahl mit 5 Ablagefächer DIN A4. Mit Abschlussblende für Beschriftung. Höhe 1420mm

Folding brochure stand, steel structure, five A4 shelves. The bottom can be used to place a graphic. Height: 1420mm.

Porte brochure pliable, fabriqué en acier. Avec 5 compartiments A4 et un espace pour un visuel. Hauteur: 1420mm.

Porta-catálogos desdobrável fabricado em aço. Possui cinco divisória A4. Altura: 1420mm.

Portafolletos plegable fabricado en acero. Cuenta con 5 bolsillos A4 y espacio para rotular gráfica. Altura: 1420mm.

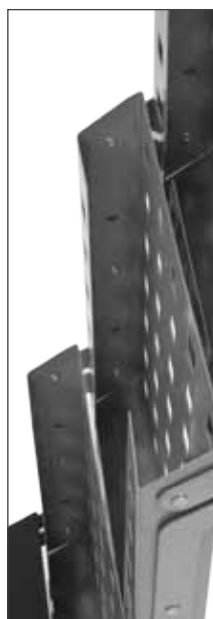

10.416

Height: 1420mm

89.00 €





Mentrida

 Faltbarer Prospektständer. Hergestellt aus Draht und Stahl. 5 x DIN A4-Fächer.

 Foldable brochure stand. Made of wire and steel. 5 x A4 portrait pockets.

 Présentoir de catalogues avec 4 divisions de dimension A4.

 Porta-catálogos desdobrável, fabricado em aço. Possui 5 divisórias A4. Possibilidade de colocar uma impressão na parte superior e inferior.

 Portafolletos plegable fabricado en tubo y varilla color negro. Cuenta con 5 bolsillos y espacio para rotular.





10.720

Height: 1460mm

36.90 €

Bañeza

 Prospektständer mit Aluminiumgestell, schwarz lackiert, 7 Broschürenfächer, mit Abschlussblenden/ Beschriftungsfläche, z.B. für firmeneigenes Logo.

 Brochure stand. Made of wire and steel. It has seven portrait pockets, size A4. Material: Steel.

 Présentoir de catalogues avec 7 divisions de dimension A4.

 Porta-catálogos em aço para catálogos A4, com 7 divisões. Parte superior e inferior disponível para colocar uma impressão.

 Portafolletos de pie, fabricado en tubo de acero pintado en negro. Cuenta con siete bolsillos y espacio para rotular gráfica.

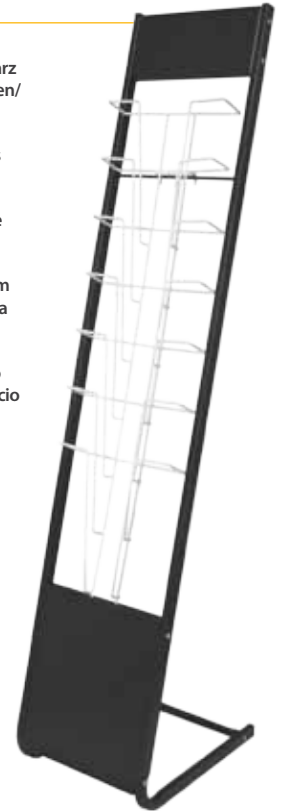



10.044

280x1360mm

34.50 €

Sil

 Leichter Prospektständer aus Nylon mit Aluminiumgestell, DIN A4. Schneller und einfacher Aufbau, ideal zum Mitnehmen. Verfügbar mit 1 oder 2 Fächerreihen. Höhe 1360mm.

 Brochure stand available for A4 catalogs. Fast and lightweight, ideal for travelling mounting demonstrations. Made of nylon and aluminum. Available in single or double version. Height: 1360mm.

 Présentoir de catalogues A4, léger, de montage facile, idéal pour les démonstrations itinérantes. Fabriqué en nylon et aluminium. Disponible en version simple ou double. Hauteur: 1360mm.

 Expositor para catálogos A4, em formato simples ou duplo. Fácil de montar e de transportar. Mala incluída. Altura: 1360mm. Material: alumínio, aço e nylon.

 Expositor soporte para catálogos tamaño A4. Montaje rápido y de poco peso, es ideal para demostraciones itinerantes. Fabricado en nylon y aluminio. Disponible en versión doble sencilla. Altura: 1360mm.

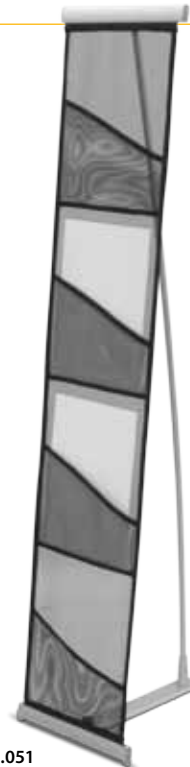

10.051

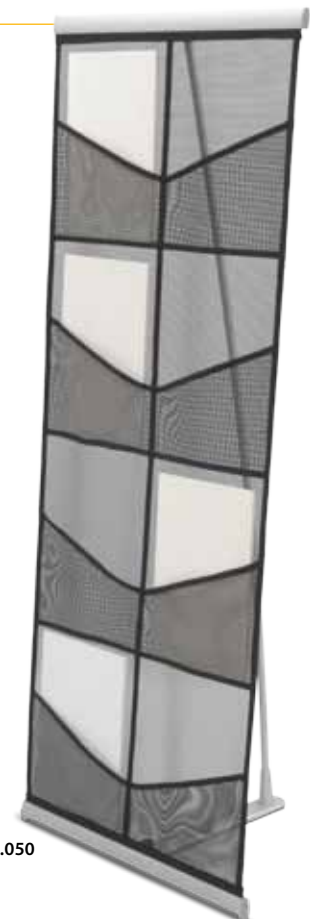

10.050

10.050

Double

31.50 €



10.051

Single

27.25 €



Legnica

 Faltbarer Prospektständer aus Aluminium, grau lackiert und transparentem Kunststoff, 8 Fächer in DIN A4 Format.

 Double Holder portable and foldable, made of transparent acrylic and gray aluminum. It consists of 8 compartments for DIN A4 brochures.

 Présentoir de catalogue double et pliable avec 8 divisions de dimension DIN A4. Fabriqué en acier et plastique.

 Porta-catálogos desdobrável em aço e acrílico. Dispõe de 8 divisórias DIN A4.

 Portafolletos doble portátil y plegable, fabricado en metacrilato transparente y aluminio gris. Consta de 8 compartimentos para folletos DIN A4.



10.114

1560mm

259.00 €



Nelas

 Drehbarer Drahtprospekthalter auf Rollen, DIN A4.

 Wire brochure holder with wheels. Shape: DIN A4. Material: Steel, plastic.

 Porte catalogue de format DIN A4 avec roulettes.

 Porta-catálogo giratório com rodas. Tamanho DIN A4. Fabricado em aço e plástico.

 Portacatálogos giratorio con ruedas, realizado en varilla. Tamaño DIN A4.



13.101

1400mm

149.50 €

Cañamo

 Prospektständer aus Aluminium mit 4 Ablageflächen aus Kunststoff. Kapazität für 2x A4 pro Ablagefläche. Größe: 620x390x1770mm.

 Single side brochure stand. Designed for 8 x A4 brochures. The feet are made of aluminium and disposes of acrylic supports. Size: 620x390x1770mm.

 Porte-brochure fabriqué en aluminium, composé de 4 supports en acrylique. Prévu pour exposer 2x A4 par support. Dimensions: 620x390x1770mm.

 Porta-catálogo fabricado em acrílico e alumínio. Cada uma das suas 4 prateleiras está concebida para dois catálogos A4. Dimensões: 620x390x1770 mm.

 Portafolletos realizado en aluminio. Dispone de 4 soportes de metacrilato para la exposición de folletos o catalogos. Válido para colocar 2xA4 por soporte. Tamaño: 620x390x1770mm.

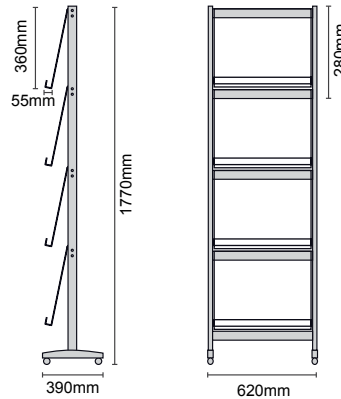

	QTY	N.W(kg)	G.W(kg)	C.B.M.	Size(mm)
Packing	1	7.3	9	0.048	410x165x720
		6.45	8.05	0.077	630x70x1750



10.468

149.00 €

Abad

 Prospektständer mit 4 Ablageflächen aus Kunststoff. Rahmen mit Klicksystem für Grafik. Kapazität für 2x A4 pro Ablagefläche. Grafikgröße: 460x260mm.

 Single side brochure stand. Designed for 8 x A4 brochures. The feet are made of aluminium and disposes of acrylic supports. Aluminium frame is using the "click" system. Size: 460x260mm.

 Porte-brochure fabriqué en aluminium, avec 4 supports en acrylique. Composé d'un cadre « click » permettant la mise en place d'un visuel dans la partie supérieure. Permet d'exposer 2 x A4 sur chaque support. Format du visuel: 460 x 260mm.

 Porta-catálogo fabricado em alumínio. Possui um marco "click" na parte superior para uma impressão de 460x260mm e 4 bandejas em acrílico que permitem a colocação de 2 catálogos A4 em cada uma.

 Portafolletos realizado en aluminio con 4 soportes de metacrilato. Dispone de un marco "click" para la colocación de gráfica en su parte superior. Válido para colocar 2xA4 por soporte. Medida de gráfica: 460x260mm.

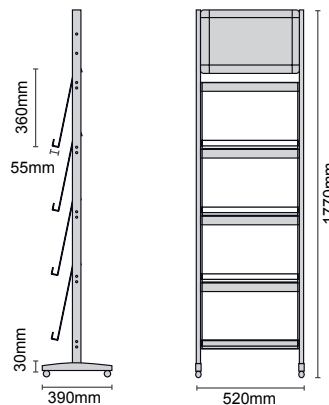

	QTY	N.W(kg)	G.W(kg)	C.B.M.	Size(mm)
Packing	1	7.3	9	0.048	410x165x720
		6.45	8.05	0.077	630x70x1750



10.467

460x260mm

159.00 €

* Druck / Printing / Impression / Impressão / Impresión.

Sotillo

Prospektständer aus Aluminium mit 4 Ablageflächen aus Kunststoff. Rahmen mit Klicksystem für Grafik. Kapazität für 3x DIN A4 pro Ablagefläche. Grafikgröße: 675x195mm.

Single side brochure stand with "click" frame. Designed for 12 x A4 brochures. The feet are made of aluminium, the supports of acrylic. Visual size: 675 x 195mm.

Porte-brochure fabriqué en aluminium, avec 4 supports en acrylique. Composé d'un cadre "click" permettant la mise en place d'un visuel dans la partie supérieure. Permet d'exposer 3 x A4 sur chaque support. Format du visuel: 675 x 195mm.

Porta-catálogo fabricado em alumínio. Possui um marco "click" na parte superior para uma impressão de 675x195 mm e 4 bandejas em acrílico que permitem a colocação de 3 catálogos A4 em cada uma.

Portafolletos realizado en aluminio. Dispone de 4 soportes de metacrilato para la exposición de folletos o catálogos y de un marco "click" en su parte superior para la colocación de gráficas. Válido para colocar 3x A4 por soporte. La medida de la gráfica del marco superior es 675x195mm.

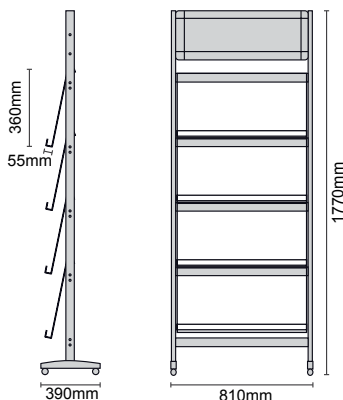

	QTY	N.W(kg)	G.W(kg)	C.B.M.	Size(mm)
Packing	1	9	10.5	0.062	410x165x920
		7.35	9.35	0.101	830x70x1750



10.469

675x195mm

199.00 €

* Druck / Printing / Impression / Impressão / Impresión.

Olmedilla

Präsentationssystem aus Aluminium mit Prospekthalter aus Kunststoff. Kapazität für 3x A4.

Double-sided brochure stand with boxes and aluminium foot. It has 1 acrylic support for displaying brochures or catalogs. Suitable for placing 3 x A4 brochures.

Porte-brochure avec demi-totem, fabriqué en aluminium. Composé d'un support en acrylique. Permet d'exposer 3 x A4 sur chaque support.

Combinado de suporte para catálogos com totem na parte superior. Fabricado em alumínio e com 1 bandeja em acrílico que permite a colocação de 3 catálogos A4.

Portafolletos con medio tótem, realizado en aluminio. Dispone de 1 soporte de metacrilato para la exposición de folletos o catálogos. Válido para colocar 3x A4 por soporte.

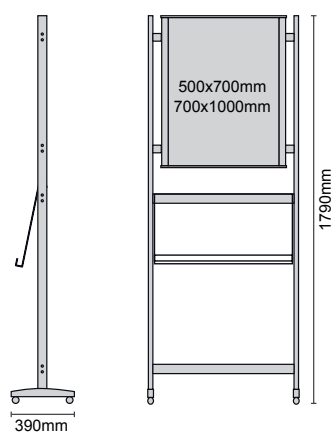

	QTY	N.W(kg)	G.W(kg)	C.B.M.	Size(mm)
Packing	1	11.5	13.4	0.243	650x205x1825

10.472

500x700mm

149.00 €



	QTY	N.W(kg)	G.W(kg)	C.B.M.	Size(mm)
Packing	1	17	18.5	0.372	850x240x1825

10.273

700x1000mm

169.00 €



Verona

Fahrbarer Prospektständer aus Aluminium und transparentem Kunststoff. Einfache Montage. Füße mit Rollen inklusive.
 Ref: 10.217: 4 transparente Ablageflächen, Breite 275mm. Kapazität für 4xA4.
 Ref: 10.218: 4 transparente Ablageflächen, Breite 750mm. Kapazität für 12xA4.

Made of aluminum and methacrylate. Includes feet with casters. Easy to assemble.
 Ref: 10.217: Has 4 shelves of 275mm wide done in methacrylate. Capacity 4xA4.
 Ref: 10.218: Has 4 shelves 750mm wide done in methacrylate. Capacity 12xA4.

Porte brochures en aluminium et acrylique. Inclus pieds avec roulettes. Montage facile.
 Réf: 10.217: Composé de 4 étagères en acrylique de 275mm de large. Capacité 4xA4.
 Réf: 10.218: Composé de 4 étagères en acrylique de 750mm de large. Capacité 12xA4.

Porta-catálogos en aluminio e acrílico. Fácil de montar e com rodas. Bandejas:
 Ref: 10.217: 340x1665x380. Capacida de: 4XA4.
 Ref: 10.218: 815x1665x380. Capacida de: 12XA4.

Realizado en aluminio y metacrilato. Incluye patas con ruedas giratorias. Fácil montaje.
 Ref: 10.217: 4 baldas de 275mm de ancho. Capacidad 4xA4.
 Ref: 10.218: 4 baldas de 750mm de ancho. Capacidad 12xA4.

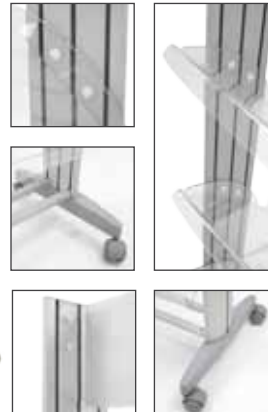

	QTY	N.W(kg)	G.W(kg)	C.B.M.	Size(mm)
Packing	1	3	3.95	0.030	420x170x430
		4.45	5	0.018	145x80x1620
10.217		255x147mm		99.00 €	



* Druck / Printing / Impression / Impressão / Impresión.

	QTY	N.W(kg)	G.W(kg)	C.B.M.	Size(mm)
Packing	1	6.8	7.85	0.071	430x185x900
		4.45	5	0.018	145x80x1620
10.218		730x147mm		159.00 €	



* Druck / Printing / Impression / Impressão / Impresión.

Athy

Wand-Prospekthalter aus Aluminium. 8xDIN A4.

Wall-Mounted leaflet dispenser. Used for 8xA4. Aluminium, acrylic.

Porte documents en aluminium à fixer au mur. Capacité : 8xA4.

Porta-catálogos de parede, fabricado em alumínio. Capacidade de 8xA4.

Portafolletos a pared fabricado en aluminio. 8 x A4.

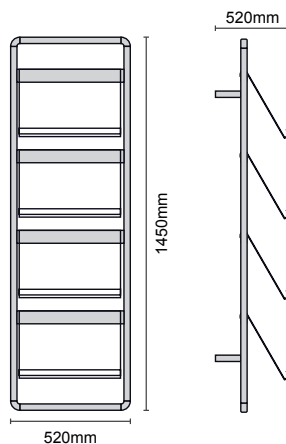

10.988

99.00 €

Cañada

Präsentationssystem aus Aluminium mit 4 Ablageflächen aus Kunststoff, einer Leuchtsäule und einem Display. Druck nicht inklusive. Kapazität für 1x DIN A4 pro Ablagefläche. Größe: 820x1700x280mm. Grafikgröße für Säule: 324x1685mm. Grafikgröße Display: 430x1100mm.

Double-sided brochure stand done in Aluminium. It has 4 mounting acrylic supports for exhibiting brochures or catalogs, a totem pole with light and a stand for a graph. Printing not included. Designed for 1xA4 brochures. Dimension 820x1700x280mm. Visual format totem: 324x1685mm. Lateral visual size: 430x1100mm.

Porte-brochure fabriqué en aluminium. Composé de 4 supports en acrylique, d'un totem lumineux et d'un support pour visuel. Permet d'exposer 1xA4 sur chaque support. Visuel non inclus. Dimension 820x1700x280mm. Format du visuel du totem: 324x1685mm. Format du visuel latéral: 430x1100mm.

Totem com porta-folhetos fabricado em alumínio. Inclui 4 suportes em acrílico para catálogos ou folhetos, um totem com luz e um suporte para impressão. Capacidade por suporte: 1xA4. Tamanho: 820x1700x280mm. Medidas de impressão totem: 324x1685mm. Medida de impressão lateral: 430x1100mm.

Portafolletos - Tótem, realizado en aluminio. Dispone de 4 soportes de metacrilato para exposición de folletos o catálogos, un tótem con luz y un soporte para una gráfica. Gráfica no incluida. Válido para colocar 1xA4 por soporte. Tamaño: 820x1700x280mm. Medida gráfica Tótem: 324x1685mm. Medida gráfica lateral: 430x1100mm.

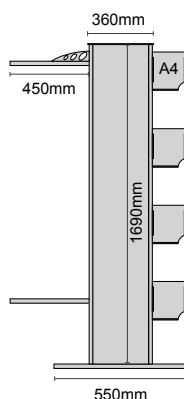
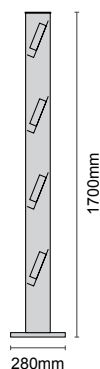

	QTY	N.W(kg)	G.W(kg)	C.B.M.	Size(mm)
Packing	1	18.5	19.7	0.375	625x345x1740

10.470

Totem 324x1685mm
Poster 430x1100mm

245.00 €



* Druck / Printing / Impression / Impressão / Impresión.

Hito

Präsentationssystem aus Aluminium mit 3 Ablageflächen aus Kunststoff und einem Display. Kapazität für 1x DIN A4 pro Ablagefläche. Größe: 880x1815x450mm. Grafikgröße Display: 600x1500mm.

Brochure holder made of aluminum. It has 3 acrylic supports for exhibiting catalogs and brochures and support for a graph. Suitable for placing 1xA4 per support. Size: 880x1815x450mm. Lateral extent graph: 600x1500mm.

Porte-brochure sur pied fabriqué en aluminium. Composé de 3 supports en acrylique et d'un support pour visuel. Permet d'exposer 1xA4 sur chaque support. Visuel non inclus. Dimension: 880x1815x450mm. Format du visuel latéral: 600x1500mm.

Suporte para impressão com porta-folhetos fabricado em alumínio. Inclui 3 suportes em acrílico para catálogos ou folhetos e um suporte para impressão. Capacidade: 3xA4. Tamanho: 880x1815x450mm. Medida de impressão: 600x1500mm.

Portafolletos realizado en aluminio. Dispone de 3 soportes de metacrilato para la exposición de folletos o catálogos y un soporte para una gráfica. Válido para colocar 1xA4 por soporte. Tamaño: 880x1815x450mm. Medida gráfica lateral: 600x1500mm.

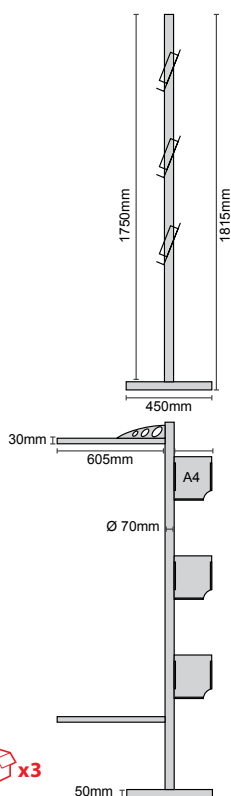

	QTY	N.W(kg)	G.W(kg)	C.B.M.	Size(mm)
Packing	1	2.8	3.6	0.0123	80x80x1920
		9.55	10	0.0156	465x72x465
		1.6	1.9	0.019	390x75x650



10.471

600x1500mm

175.00 €



* Druck / Printing / Impression / Impressão / Impresión.