

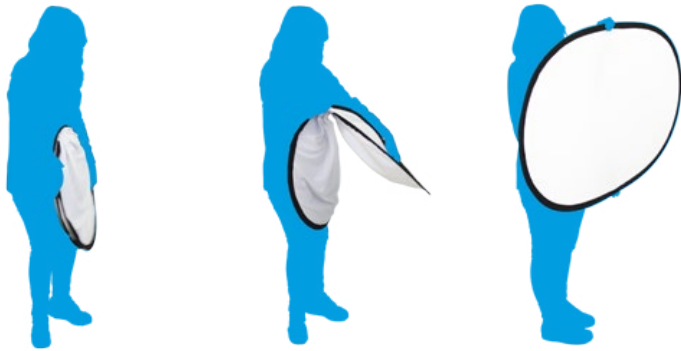

X-BANNER	4
L-BANNER	6
ROLL UP BANNER	8
ROLL UP ACCESSORIES	32
MINI BANNER	36
SUCTION CUPS BANNER	38
CROSS - TRIPLE BANNER	40
BAMBOO BANNER	41
OUTDOOR BANNER	42
BEACH BANNER	53
FLYING BANNER	54
FLYING BANNER ACCESSORIES	56
BACKPACK BANNER	57
INDOOR FLYING BANNER	58
EXTERIOR SOLUTIONS	60
FASHION POP UP   EXHIBITION WALL	67
BARRIER BANNER	68
FABRIC POP UP	70
POP UP	75
POP UP ACCESSORIES	84
TEXTFIX	88
TEXTFIX ACCESSORIES	110
QUICK SYSTEM	114
POSTER DISPLAY	118
PROMOTION COUNTERS	131
POSTER SYSTEM	142
DISPENSER DISPLAYS	148
TURNTABLES	160

## SILVES GOLF BANNER



EN Foldable banner, easy installation, ideal for indoor and outdoor events. Available in 3 sizes. Components: Carry bag, hooks, fiberglass pole connectors, fiberglass pole and black fabric of 60mm width.

FR Banner pliable, montage facile, idéal pour des événements d'intérieur ou d'extérieur. Disponible en 3 dimensions. Inclus: Sac de transport, crochets métalliques de fixation, baguette en fibre, connexion pour les baguettes en fibre et textile noir de 60mm de large.

PT Expositor em tecido para exterior. Este sistema permite que uma só pessoa monte o expositor de forma fácil e rápida. Conteúdo: Bolsa de transporte, ganchos metálicos para fixar, uniões para as barras de fibra, barras de fibra e tela preta com 60mm para o rebordo.

ES Banner plegable de fácil montaje ideal para eventos tanto de interior como de exterior. Disponible en 3 tamaños. Componentes: Bolsa de transporte, ganchos metálicos para clavar (piquetas), barras de fibra, conectores y tela negra de 60mm de ancho de borde.



### INFORMATION

\*mm

- Extremely portable and lightweight.
- Flexible fiberglass providing greater stability and improved performance without the need for any assembly.

- Available in 3 sizes. Carry bag included.
- Ideal for making your message stand out from the crowd at any event either indoors or outdoor.

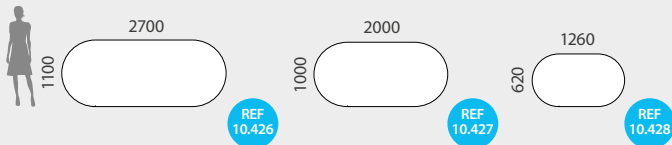

SILVES 1100	QTY	N.W	G.W	C.B.M	SIZE
Packing	5	12.50kg	13kg	0.26	1200x180x1200mm
Uni.	1	2.50kg	2.60kg	0.05	1140x30x1140mm
<b>10.426</b>	Graphic Size: 1100x2700mm				<b>67.50 €</b>

SILVES 1000	QTY	N.W	G.W	C.B.M	SIZE
Packing	5	8.50kg	8.9kg	0.17	960x180x960mm
Uni.	1	0.90kg	1kg	0.045	950x50x950mm
<b>10.427</b>	Graphic Size: 1000x2000mm				<b>61.25 €</b>

SILVES 620	QTY	N.W	G.W	C.B.M	SIZE
Packing	5	7kg	7.25kg	0.08	660x180x660mm
Uni.	1	1.40kg	1.45kg	0.012	640x30x640mm
<b>10.428</b>	Graphic Size: 620x1260mm				<b>55.00 €</b>



# OUTDOOR BANNER | Refillable Base Banner





- EN Outdoor banner stand with water fillable bases, offering impressive single or double-sided graphic displays. Laquered aluminium and plastic parts.
- FR Support visuel idéal pour l'extérieur. Avec base en plastique à remplir d'eau. Disponible en simple et double face. Fabriqué en aluminium et plastique.
- PT Banner de exterior com reservatórios na base que se podem encher com água ou areia. Oferece um grande impacto visual tanto em simples como em dupla face.
- ES Soportes visuales con bases rellenas de agua, ideales para su uso en exteriores. Disponibles a una o doble cara. Fabricados en aluminio lacado y partes de plástico.

- EN Fiberglass, plastic and laquered aluminium.
- FR Fibre de verre, plastique et aluminium.
- PT Fibra de vidro, plástico e alumínio lacado.
- ES Fibra de vidrio, plástico y aluminio lacado.

**INFORMATION** \*mm

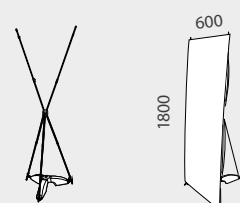
- Carry bag included.
- Portable | Detachable.
- Refillable with 6l water.
- Easy interchangeable graphic.
- Suitable for indoor or outdoor.
- Fiberglass, lacquered aluminium.



ALMAZAN	QTY	N.W	G.W	C.B.M	SIZE	
Pole	1	0.55kg	0.6kg	0.004	80x65x750mm	
Base	1	0.95kg	1kg	0.015	250x170x350mm	

 10.028
35.00 €

## ALMAZAN

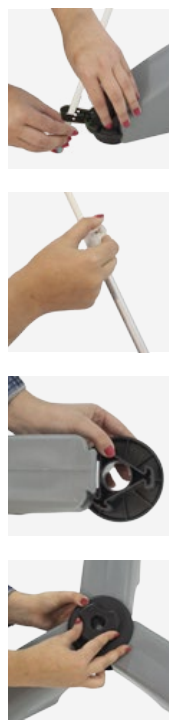



6 L water refillable

- EN Fiberglass, plastic and laquered aluminium. Adjustable height
- FR Fibre de verre, plastique et aluminium. Ajustable en hauteur.
- PT Fibra de vidro, plástico e alumínio lacado. Ajustável em altura.
- ES Fibra de vidrio, plástico y aluminio lacado. Regulable en altura.

**INFORMATION** \*mm

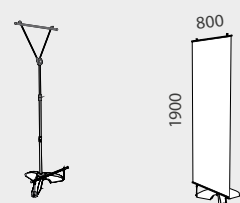
- Carry bag included.
- Portable | Detachable.
- Refillable with 6l water.
- Easy interchangeable graphic.
- Adjustable height (telescopic).
- Suitable for indoor or outdoor.
- Fiberglass, lacquered aluminium.



ALMENAR	QTY	N.W	G.W	C.B.M	SIZE	
Packing	6	13kg	16.20kg	0.1	400x320x850mm	
Uni.	1	1.8kg	2.2kg	0.02	240x100x840mm	

 10.029
56.00 €

## ALMENAR

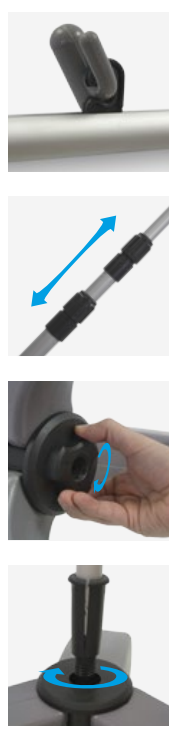

telescopic



6 L water refillable



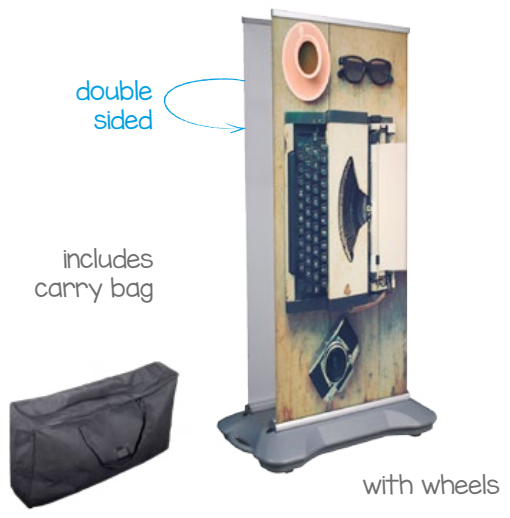

# OUTDOOR BANNER | Refillable Base Banner

EN	Double-sided. Plastic and laquered aluminium.
FR	Double face. Fabriqué en plastique et aluminium.
PT	Expositor de dupla face. Em plástico e alumínio lacado.
ES	Doble cara. Realizado en plástico y aluminio lacado.



**INFORMATION** \*mm

Haro is a detachable double-sided display made of fiberglass and laquered aluminium, with a refillable 56l base which is suitable for indoor and outdoor use. Features a nylon Carry Bag. Place this sidewalk display outdoors in areas with high foot traffic, such as a lobby or outside your business.

HARO	QTY	N.W	G.W	C.B.M	SIZE		
Packing	1	17.7kg	19.6kg	0.17	620x230x1160mm		
	10.954	Graphic Size: 800x2000mm (x2)			<b>199.00 €</b>		

**INFORMATION** \*mm



Medinaceli is a detachable poster display with a refillable 12l water plastic base which is suitable for indoor and outdoor use. The change of graphic is simple and takes only a few seconds. Features a nylon Carry Bag for an easy transport and storing. Place this sidewalk display outdoors in areas with high foot traffic, such as a lobby or outside your business. Ideal for displaying at expositions, events, outdoor markets or at tradeshows.



**MEDINACELI**

fill it with 12 L water

includes carry bag

MEDINACELI	QTY	N.W	G.W	C.B.M	SIZE		
Packing	2	7kg	8.6kg	0.11	540x190x1050mm		
Uni.	1	2.85kg	3.50kg	0.05	500x100x1030mm		
	10.026	Graphic Size: 450x1560mm			<b>46.75 €</b>		

PANELFIX WING  
OUTDOOR

INFORMATION \*mm

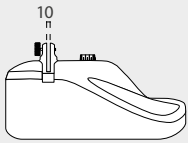

refillable

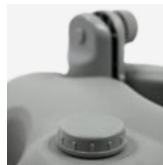

With a durable design and easy portability, this double-sided base with corrugated plastic insert is a go to for many marketers and advertisers. Place this sidewalk display outdoors in areas with high foot traffic, such as a lobby or outside your business, to draw in new customers. The weighted poster holder can be filled with up to 5l of water or sand. This base is available on Grey or black color.

PANELFIX WING	QTY	N.W	G.W	C.B.M	SIZE		
Packing	1	2kg	2.55kg	0.04	440x190x520mm		
	10.442						
	10.443						
						x2	<b>39.50 €/Uni</b>



INFORMATION \*mm

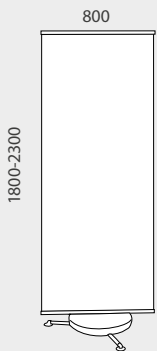

telescopic

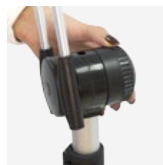

Cepeda is a telescopic poster display with a refillable 20l base which is suitable for indoor and outdoor use. The change of graphic is simple and takes only a few seconds. Features a nylon Carry Bag. Place this sidewalk display outdoors in areas with high foot traffic, such as a lobby or outside your business.

CEPEDA	QTY	N.W	G.W	C.B.M	SIZE		
Pole	1	1.5kg	1.7kg	0.01	100x90x1160mm		
Base	1	2kg	2.25kg	0.05	460x240x470mm		
	10.800	Graphic Size: 800x1800-2300mm					<b>67.00 €</b>

CEPEDA

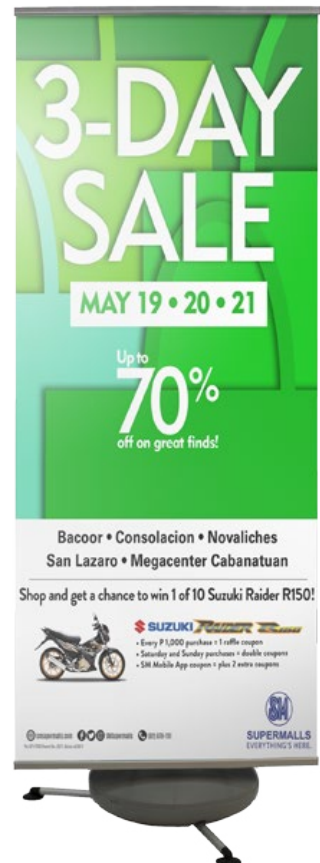



fill each base with 25 L water or sand

## BARAHONA

5.6m Width

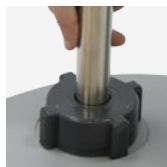
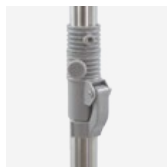
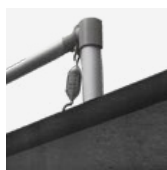

### INFORMATION

- With 2 Bases (fill each one with 25l water or sand).
- Barahona "1" is ideal as large graphic banner display (one or two-sided) also is perfect for an outdoor use, with bases which can resist strong wind conditions.

### BARAHONA 1

10.030 QTY:+25

**174.30 €/u**

QTY:+10 **199.20 €/u**

QTY:+5 **224.10 €/u**

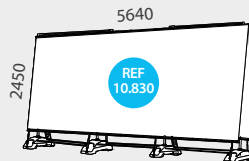
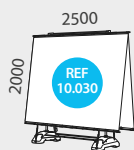

- With 4 Bases (fill each one with 25l of water or sand), Barahona "2" is ideal as large graphics display (1 or 2-sided). Its 4 ultra-large bases are very stable for an outdoor use, which ones are available to resist strong wind conditions. Barahona "2" is the first choice for a huge outdoor display background (visual: 5640x2450mm).

\*mm

BARAHONA 1	QTY	N.W	G.W	C.B.M	SIZE	
Pole	1	11.5kg	16kg	0.04	410x210x1660mm	 25 L x2 Bases
Base	1	8kg	9kg	0.11	430x310x850mm	

Graphic Size: 2500x2000mm

**249.00 €**

BARAHONA 2	QTY	N.W	G.W	C.B.M	SIZE	
Pole	1	17.2kg	21.1kg	0.044	170x150x1720mm	 25 L x4 Bases
Base	1	13.30kg	18.3kg	0.12	470x300x850mm	

Graphic Size: 5640x2450mm

**499.00 €**

KIEL



single



double-sided





INFORMATION

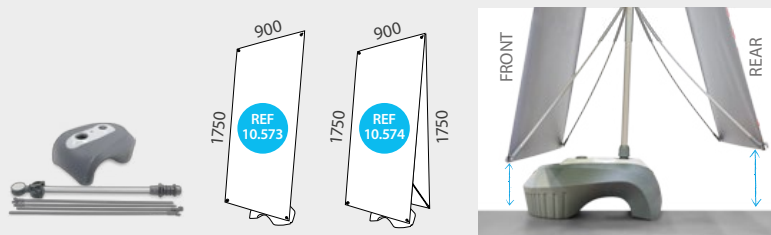

\*mm

- Refillable 20L water base.
- Telescopic support pole and the central hub allows the adjustment of height. Fast set-up.
- Built for durability and strength, Kiel is ideal for indoor or outdoor promotion, and as it can be used to present a double-sided graphic (ideal for areas with 2-ways traffic). Graphics are held with a simple and fast eyelet system.



- In the double-sided Kiel 10.574, after the placement of graphs the **distance** to the ground on both sides can differentiate each other: **± 50mm**.

KIEL SINGLE	QTY	N.W	G.W	C.B.M	SIZE	
Packing	1	2.8kg	3.25kg	0.09	400x200x1080mm	 20L 
 10.573	Graphic Size: 900x1750mm				<b>66.00 €</b>	

KIEL DOUBLE	QTY	N.W	G.W	C.B.M	SIZE	
Packing	1	3kg	3.45kg	0.09	400x200x1080mm	 20L 
 10.574	Graphic Size: 900x1750mm x2				<b>68.75 €</b>	



## CHARLEROI



double sided



### INFORMATION

\*mm

- Double sided.
- Fill its base with 4l water/sand.
- It allows the barriers mounting thanks to its 2 chain connections.
- Ideal for indoor or outdoor use like shop entrances, sidewalks gardens, restaurant terraces, etc.

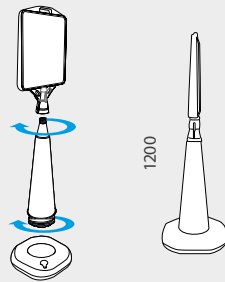

CHARLEROI	QTY	N.W	G.W	C.B.M	SIZE
Packing	1	2kg	2.5kg	0.07	500x200x690mm



10.248

Graphic Size: 330x382mm

53.65 €



## DELTA

### INFORMATION

ARTWORK

\*mm

Delta sidewalk double sided board is built with long-lasting plastic to resist rust and other weather-related damage. Able to fit 550x748mm posters with maximum thickness of 5mm. Also the change of graphic is fast and simple thanks its top insert slots. With a carrying handle, Delta folds down quickly for carrying and an easy storage. This indoor and outdoor sidewalk sign is lightweight for transport but large enough to attract attention in any area. Any business can rely on these displays, as the non-slip feet keep them steady on both pavement and bumpy grass. Try this sidewalk sign outside of your store to attract customers and promote yourself effectively. Perfect for any high-traffic area.

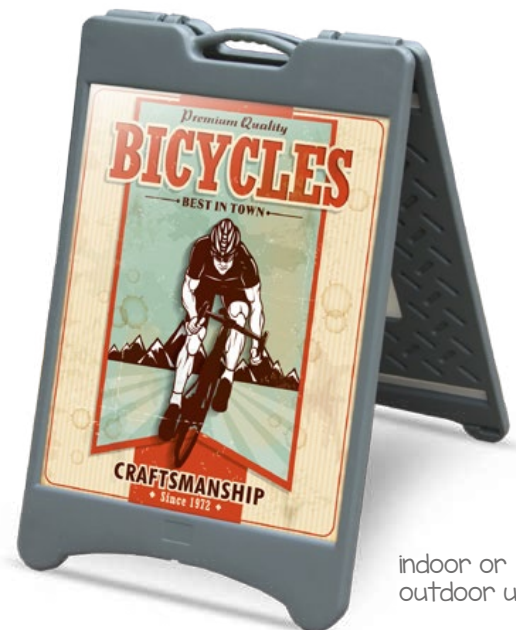

indoor or outdoor use

DELTA	QTY	N.W	G.W	C.B.M	SIZE
Packing	1	7kg	8kg	0.05	630x80x1010mm

10.679

Graphic Size: 550x748mm

69.90 €



OCEAN



INFORMATION

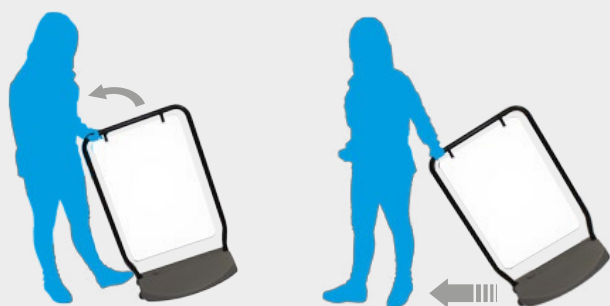
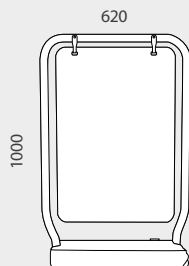

\*mm

Resting on a plastic 10l water-refillable base, Ocean outdoor unit is designed for indoor and outdoor use. With an oscillating 620x1000mm board, the advertising options are numerous for your business outdoor sign. Each board is double-sided for twice the promotion. When you need to move the unit, the built-in wheels let you easily reposition to a better location or bring it inside at the end of the work day.



- 1 First, use the foot to tilt the board slightly toward to you.
- 2 Then, move the Ocean Display behind you using its wheels.



OCEAN	QTY	N.W	G.W	C.B.M	SIZE	
Packing	1	5.4kg	7.0kg	0.17	1100x140x1100mm	 

 10.305      Graphic Size: 500x750mm      **69.00 €**

# OUTDOOR BANNER | Flagpoles



- EN Outdoor flagpoles with heavy refillable bases which allows a great stability. Made of aluminium and plastic parts. Visible at a great distance.
- FR Banderoles extérieure en aluminium et base en plastique remplissable d'eau. Permet la visualisation des images à grande distance.
- PT Mastro de exterior para a colocação de duas imagens. Possui uma base onde se pode colocar água. Fabricado em alumínio e plástico.
- ES Sistema para banderas de exterior en aluminio con bases de plástico rellenas que proporcionan gran estabilidad. Visibles a larga distancia.

## YUSTE

4.5m

double sided

telescopic

6 L water

**INFO**      ARTWORK      \*mm

4500

1500 - ±4500

600

- Telescopic.
- Refillable 6l base.
- Carry bag is included.
- Can be used with two banners.

## BREST

4.1m

improved stability

heavy base

telescopic

50 L of sand/water

**INFO**      ARTWORK      \*mm

4100

± 2800

800

- Telescopic.
- Carry bag is included.
- Foldable feet structure.
- Refillable 50l heavy base.

YUSTE	QTY	N.W	G.W	C.B.M	SIZE	
Pole	1	1.35kg	1.85kg	0.015	120x80x1650mm	 6L
Base	1	0.95kg	1.15kg	0.017	260x200x340mm	
10.709	Graphic Size: ± 600x1500-4500mm (x2)					<b>64.00 €</b>

BREST	QTY	N.W	G.W	C.B.M	SIZE	
Pole	1	4.1kg	5.1kg	0.029	135x135x1610mm	 50L
Base	1	6kg	6.3kg	0.117	665x265x665mm	
*10.652	Graphic Size: ± 800x2800mm					<b>129.00 €</b>



BEJAR



<b>BEJAR</b>	
10.031	QTY:+25
<b>87.50 €/u</b>	
QTY:+10	100.00 €/u
QTY:+5	112.50 €/u



improved stability



heavy base

5m



telescopic



76 L of sand/water



INFO ARTWORK \*mm

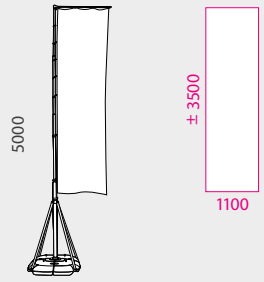

- Telescopic.
- Carry bag is included.
- Foldable feet structure.
- Refillable 76l heavy base.

BEJAR	QTY	N.W	G.W	C.B.M	SIZE	
Pole	1	7.5kg	9.8kg	0.04	160x130x1680mm	76L
Base	1	10kg	11kg	0.14	430x380x850mm	
10.031 Graphic Size: 1100x3500mm						<b>125.00 €</b>



EN Big Flag dimensions.  
FR Grandes dimensions.  
PT Grandes dimensões.  
ES Grandes dimensiones.



60 L of sand/water



## CERGY

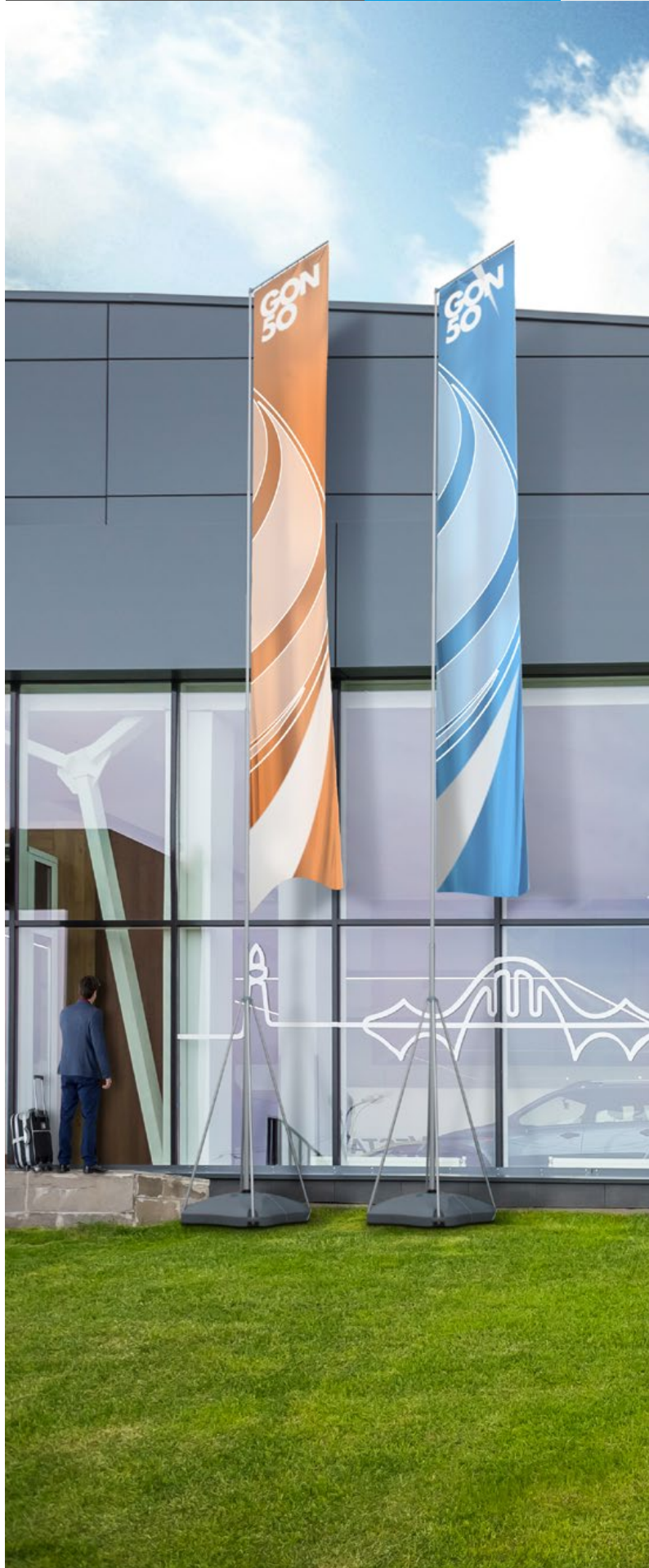

### INFORMATION

### ARTWORK \*mm

- Carry bag is included.
- With adjustable height thanks to its telescopic aluminium pole.
- With water Refillable 60 l base.
- For the biggest flags dimensions, with two heights available: 7 or 9m.

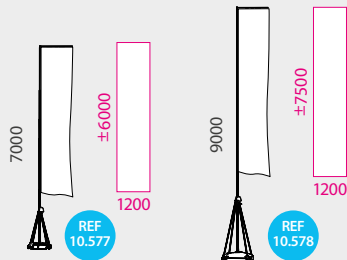

CERGY 6000	QTY	N.W	G.W	C.B.M	SIZE	
Pole	1	6.5kg	7.5kg	0.03	150x130x1710mm	
Base	1	8kg	9kg	0.13	410x410x805mm	
<b>10.577</b>	Graphic Size: ± 1200x6000mm					<b>240.00 €</b>
CERGY 7500	QTY	N.W	G.W	C.B.M	SIZE	
Pole	1	8.5kg	9.5kg	0.05	180x170x1710mm	
Base	1	14kg	15kg	0.24	510x510x920mm	
<b>10.578</b>	Graphic Size: ± 1200x7500mm					<b>340.00 €</b>





SQUARE



ARTWORK \*mm

SAFE ZONE  
TOTAL GRAPHIC

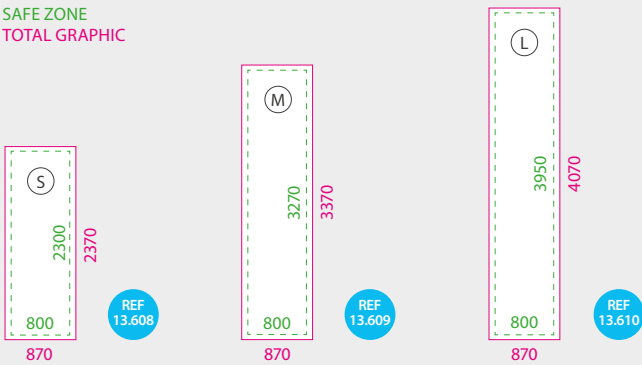

INFORMATION

- Carry bag is included.
- Ideal for promoting at beach.
- Multiple accessories available:

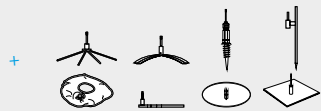

SQUARE S	QTY	N.W	G.W	C.B.M	SIZE	
Packing	1	0.94kg	1.44kg	0.004	80x50x1050mm	
<b>* 13.608</b>					<b>S</b>	<b>23.40 €</b>
SQUARE M	QTY	N.W	G.W	C.B.M	SIZE	
Packing	1	1.46kg	1.96kg	0.005	100x50x1050mm	
<b>* 13.609</b>					<b>M</b>	<b>31.35 €</b>
SQUARE L	QTY	N.W	G.W	C.B.M	SIZE	
Packing	1	1.80kg	2.30kg	0.005	100x50x1050mm	
<b>* 13.610</b>					<b>L</b>	<b>36.05 €</b>



FLYING BANNER	
EN	Flying Banner featuring different bases. The price includes only the pole.
FR	Mât pour drapeaux. Possibilité de choisir parmi plusieurs socles. Prix du mât.
PT	Mastro para exterior que se adapta a diferentes bases. Preço do mastro.
ES	Flying Banner puede combinarse con distintas bases. Precio sólo del poste.

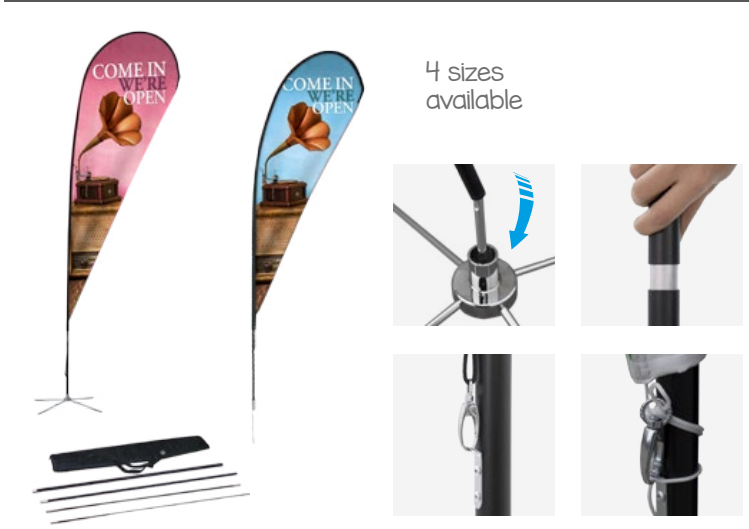

4 sizes available

## SPOON

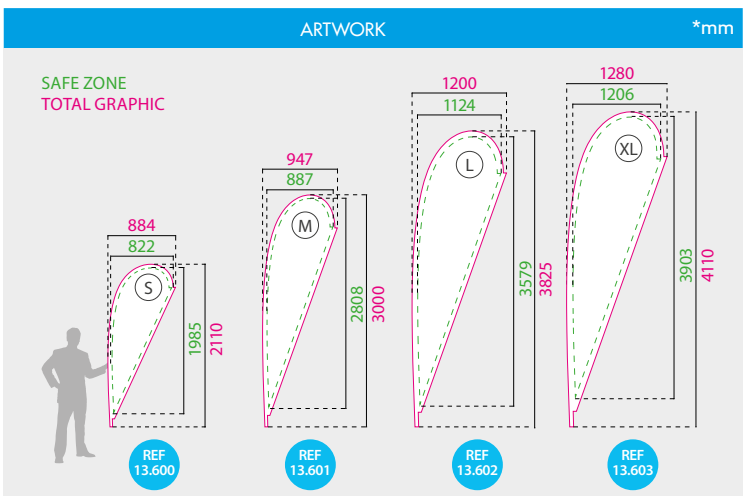

**INFORMATION**

- Carry bag is included.
- Multiple accessories available.
- Aluminium, fiberglass and plastic.
- Ideal for using at a variety of events.

The pole included with this display is collapsible for an easy portability.

SPOON S	QTY	N.W	G.W	C.B.M	SIZE	
Packing	1	0.67kg	0.72kg	0.004	65x50x1410mm	
<b>13.600</b>				<b>S</b>		<b>27.50 €</b>
SPOON M	QTY	N.W	G.W	C.B.M	SIZE	
Packing	1	1.07kg	1.57kg	0.005	80x50x1410mm	
<b>13.601</b>				<b>M</b>		<b>34.95 €</b>
SPOON L	QTY	N.W	G.W	C.B.M	SIZE	
Packing	1	1.49kg	1.99kg	0.005	80x50x1410mm	
<b>13.602</b>				<b>L</b>		<b>45.30 €</b>
SPOON XL	QTY	N.W	G.W	C.B.M	SIZE	
Packing	1	1.78kg	2.28kg	0.005	80x50x1410mm	
<b>13.603</b>				<b>XL</b>		<b>48.50 €</b>



KNIFE



4 sizes available

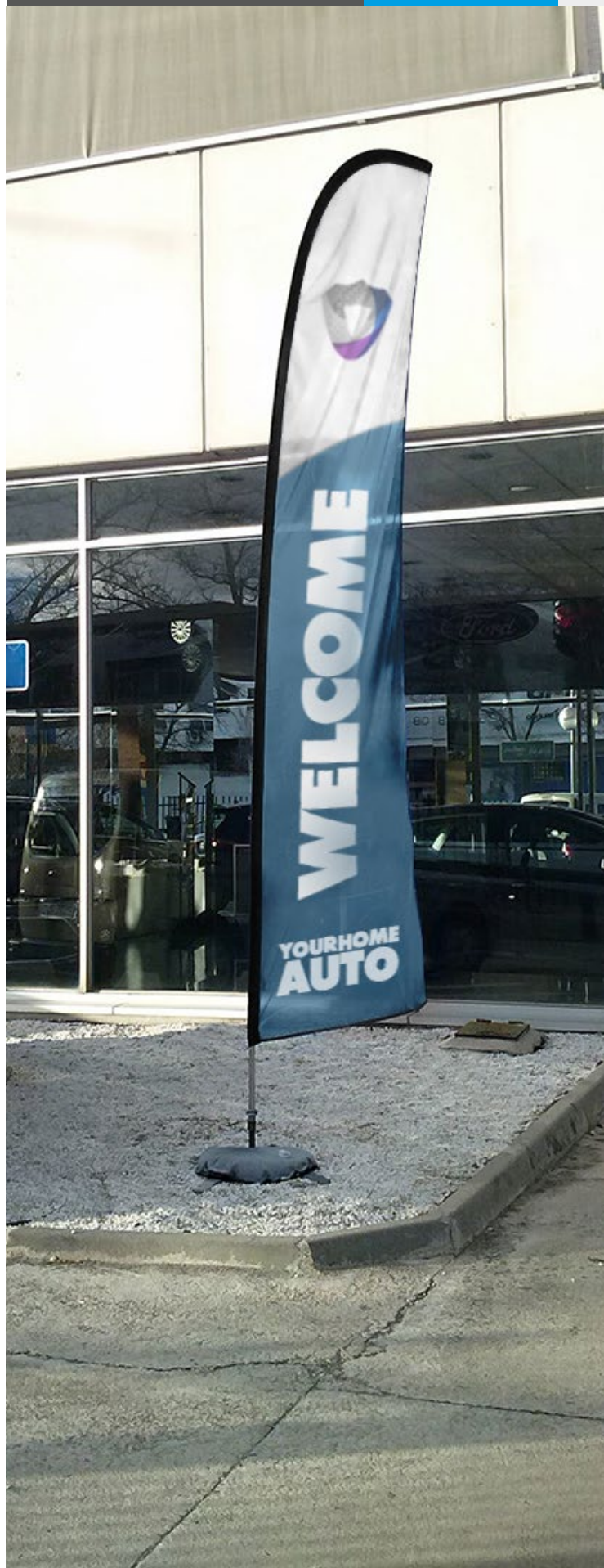

ARTWORK \*mm

SAFE ZONE  
TOTAL GRAPHIC

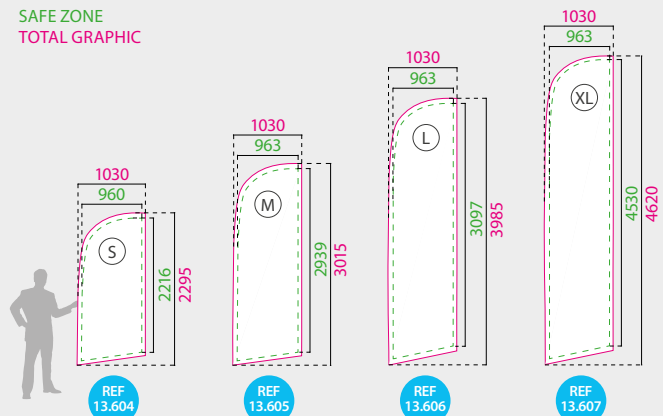

INFORMATION

- Carry bag is included.
  - Multiple accessories available.
  - Aluminium, fiberglass and plastic.
  - Ideal for using at a variety of events.
- The pole included with this display is collapsible for an easy portability.

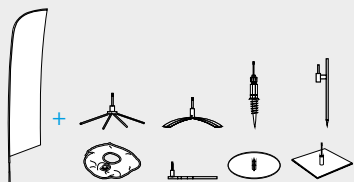

KNIFE S	QTY	N.W	G.W	C.B.M	SIZE	
Packing	1	0.94kg	1.44kg	0.005	80x50x1410mm	
<b>* 13.604</b>					<b>(S)</b>	<b>19.75 €</b>
KNIFE M	QTY	N.W	G.W	C.B.M	SIZE	
Packing	1	1.15kg	1.65kg	0.005	80x50x1410mm	
<b>* 13.605</b>					<b>(M)</b>	<b>21.75 €</b>
KNIFE L	QTY	N.W	G.W	C.B.M	SIZE	
Packing	1	1.60kg	2.10kg	0.005	80x50x1410mm	
<b>* 13.606</b>					<b>(L)</b>	<b>25.55 €</b>
KNIFE XL	QTY	N.W	G.W	C.B.M	SIZE	
Packing	1	1.65kg	2.15kg	0.006	90x50x1410mm	
<b>* 13.607</b>					<b>(XL)</b>	<b>31.90 €</b>

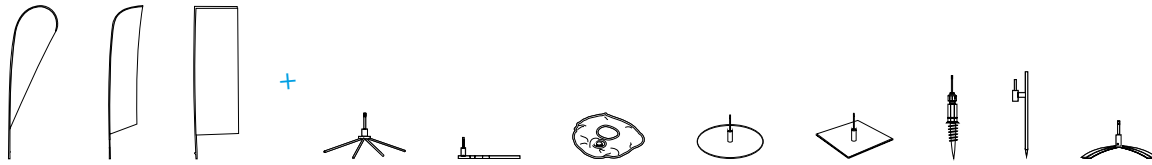

### CROSS BASE WITH WATER PLASTIC BAG

3 L bag included



CROSS BASE	QTY	N.W	G.W	C.B.M	SIZE
Packing	40	28kg	31kg	0.115	620x460x720mm
Uni.	1	0.7kg	0.77kg	0.025	350x110x590mm

**\*13.611** **24.95 €**

#### INFORMATION \*mm

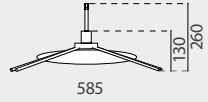

- With 3l refillable bag.
- Ideal for using with the larger flags, also can be used on uneven ground (even on slopes).

### TIRE BASE U STYLE

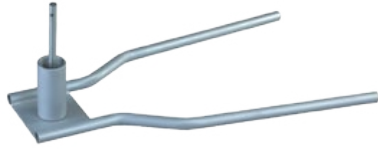

U STYLE	QTY	N.W	G.W	C.B.M	SIZE
Packing	20	34kg	37kg	0.138	540x400x640mm
Uni.	1	1.7kg	1.85kg	0.028	380x120x620mm

**\*13.614** **24.95 €**

#### INFORMATION \*mm

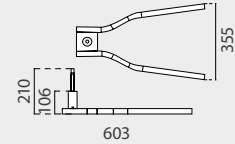

- Fast to assemble.
- Ideal for installation under car wheel thanks its U shape.

### WATER PLASTIC BAG



3 L water

W.P.BAG	QTY	N.W	G.W	C.B.M	SIZE
Packing	20	3kg	4kg	0.006	200x150x200mm
Uni.	1	0.15kg	0.2kg	0.009	140x40x160mm

**\*10.766** **6.10 €**

#### INFORMATION



- Great stability.
- Fast to assemble.
- Add an extra 3l weight.
- Suitable for Cross-Plate, Round and Square bases.

### ROUND PLATE BASE



ROUND	QTY	N.W	G.W	C.B.M	SIZE
Packing	1	8kg	8.5kg	0.014	530x45x590mm

**\*13.615** **49.95 €**

#### INFORMATION \*mm

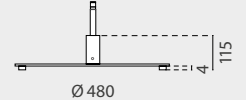

- Great stability.
- Fast to assemble.
- Recommended for an outdoor or indoor use with all Flying Banners.

### GROUND DRILL



DRILL	QTY	N.W	G.W	C.B.M	SIZE
Packing	20	12kg	15kg	0.115	460x410x610mm
Uni.	1	0.6kg	0.75kg	0.025	390x110x590mm

**\*13.612** **14.25 €**

#### INFORMATION \*mm

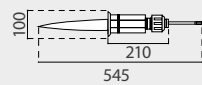

- Fast to assemble.
- For soft grounds, sand or snow. Ideal for displaying at the beach in summer or ski slopes in winter.

### SQUARE PLATE BASE



SQUARE	QTY	N.W	G.W	C.B.M	SIZE
Packing	1	6kg	6.5kg	0.014	530x45x590mm

**\*13.616** **49.95 €**

#### INFORMATION \*mm

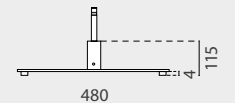

- Great stability.
- Fast to assemble.
- Recommended for an outdoor or indoor use with all Flying Banners.

### ROUND STRAIGHT SPIKE

ideal for grass or soft grounds



SPIKE	QTY	N.W	G.W	C.B.M	SIZE
Packing	20	30kg	33kg	0.061	300x225x610mm
Uni.	1	1.5kg	1.65kg	0.009	55x40x590mm

**\*13.613** **23.50 €**

#### INFORMATION \*mm

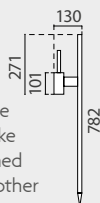

- Fast assembly.
- By the own nature of the ground spike being driven pushed into the grass or other soft grounds, providing a very stable platform.

### CROSS PLATE BASE



CROSS	QTY	N.W	G.W	C.B.M	SIZE
Packing	5	21.5kg	24kg	0.030	320x120x800mm
Uni.	1	4.3kg	4.8kg	0.005	110x60x780mm

**\*13.617** **36.00 €**

#### INFORMATION \*mm

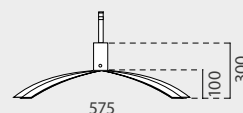

- Great stability.
- Fast to assemble.
- Ideal for concrete surfaces, footpaths or also, for indoor use.



**EN** Promotional system composed by a lightweight and comfortable backpack and an exhibition structure. Ideal for exhibitions or streetmarketing. With Carry bag.

**FR** Système portable pour publicité qui comprend un sac à dos confortable et très léger avec une structure publicitaire. Préconisé pour des salons ou street marketing.

**PT** Sistema transportável para propaganda, composto por uma mochila confortável (e leve) e uma estrutura publicitária. Ideal para feiras/streetmarketing. Com bolsa de transporte.

**ES** Sistema de promoción portatil compuesto por una mochila ultraligera comfortable y una estructura publicitaria, ideal en ferias o streetmarketing. Con bolsa de transporte.

## X-BANNER BACKPACK



**INFORMATION** \*mm

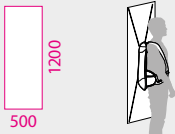

**TOTAL GRAPHIC**

- Shoulder buckles.
- Soft-Padded for back.
- Side and top pockets.
- Fiberglass X-structure.



X-BANNER	QTY	N.W	G.W	C.B.M	SIZE
Packing	1	1.1kg	1.25kg	0.03	650x100x400mm

**10.760** Graphic Size: 500x1200mm **57.50 €**

## FLAG BANNER BACKPACK



**INFORMATION** \*mm

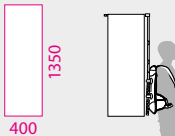

**TOTAL GRAPHIC**

- Telescopic pole.
- Shoulder buckles.
- Side and top pockets.
- Soft-Padded for back.



## TEARDROP BANNER BACKPACK

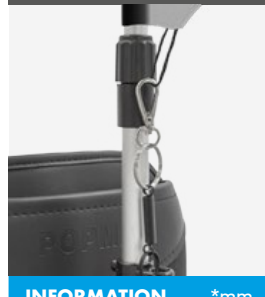

**INFORMATION** \*mm

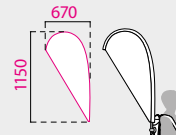

**TOTAL GRAPHIC**

- With flag tensor.
- Shoulder buckles.
- Soft-Padded for back.
- Side and top pockets.



FLAG BANNER	QTY	N.W	G.W	C.B.M	SIZE
Packing	1	1.1kg	1.25kg	0.03	650x100x400mm

**10.794** Graphic Size: 400x1350mm **57.50 €**

TEARDROP BANNER	QTY	N.W	G.W	C.B.M	SIZE
Packing	1	1.2kg	1.35kg	0.03	650x100x400mm

**10.795** Graphic Size: 670x1150mm **57.50 €**

# INDOOR FLYING BANNER | Indoor Flying Banner



- EN Indoor Flying Banner. You can choose a flying banner base feet covered with an anti-scratch soft velvet finish. The price includes only the pole.
- FR Drapeaux d'intérieure disponible en 6 modèles différents. Possibilité d'être utilisé un socle avec finition anti-rayures . Prix seulement du mât.
- PT Bandeira para interior disponível em 6 modelos diferentes. A base, vendida por separado, tem um revestimento que evita riscos. Preço do mastro.
- ES Flying Banner de interior. Puede combinarse con una base antideslizante provista de revestimiento anti-arañazos. El precio incluye sólo el poste.

### TEARDROP

**ARTWORK** \*mm

**SAFE ZONE**  
**TOTAL GRAPHIC**

**INFORMATION**

- Fast to assemble.
- Carry bag included.
- Suitable with indoor round base.
- Ideal for supermarkets, shops or indoor promotional events.

TEARDROP	QTY	N.W	G.W	C.B.M	SIZE
Packing	1	0.50kg	0.65kg	0.0087	145x60x1000mm

**\* 13.621**    Graphic: 600x1500mm    Safe: 560x1460mm    **24.80 €**



### FEATHER

**ARTWORK** \*mm

**SAFE ZONE**  
**TOTAL GRAPHIC**

**INFORMATION**

- Fast to assemble.
- Carry bag included.
- Suitable with indoor round base.
- Ideal for supermarkets, shops or indoor promotional events.

FEATHER	QTY	N.W	G.W	C.B.M	SIZE
Packing	1	0.40kg	0.55kg	0.0087	145x60x1000mm

**\* 13.622**    Graphic: 500x1400mm    Safe: 460x1360mm    **23.40 €**

### SQUARED

**ARTWORK** \*mm

**SAFE ZONE**  
**TOTAL GRAPHIC**

**INFORMATION**

- Fast to assemble.
- Carry bag included.
- Suitable with indoor round base.
- Ideal for supermarkets, shops or indoor promotional events.

SQUARED	QTY	N.W	G.W	C.B.M	SIZE
Packing	1	0.40kg	0.55kg	0.0087	145x60x1000mm

**\* 13.623**    Graphic: 500x1400mm    Safe: 460x1360mm    **23.40 €**



## SENATOR

### ARTWORK \*mm

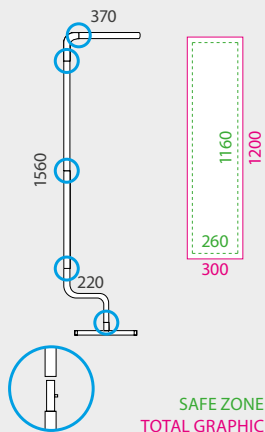

SAFE ZONE  
TOTAL GRAPHIC



### INFORMATION

- Fast to assemble.
- Counterweight and bag included.
- Suitable with indoor round base.
- Ideal for supermarkets, shops or indoor promotional events.

SENATOR	QTY	N.W	G.W	C.B.M	SIZE
Packing	1	0.45kg	0.60kg	0.0087	145x60x1000mm
	13.624	Graphic: 300x1200mm		Safe: 260x1160mm	<b>23.95 €</b>

## RAZOR

### ARTWORK \*mm

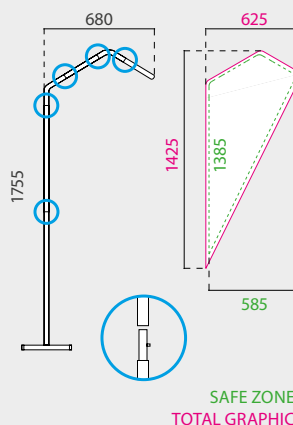

SAFE ZONE  
TOTAL GRAPHIC



### INFORMATION

- Fast to assemble.
- With carry bag included.
- Suitable with indoor round base.
- Ideal for supermarkets, shops or indoor promotional events.

RAZOR	QTY	N.W	G.W	C.B.M	SIZE
Packing	1	0.45kg	0.60kg	0.0087	145x60x1000mm
	13.625	Graphic: 625x1425mm		Safe: 585x1385mm	<b>23.95 €</b>

## KITE

### ARTWORK \*mm

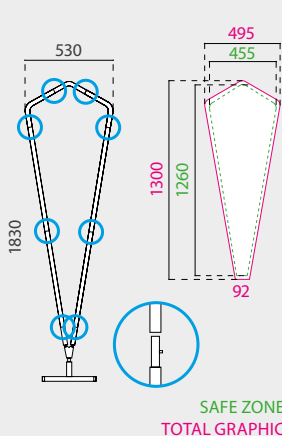

SAFE ZONE  
TOTAL GRAPHIC



### INFORMATION

- Fast to assemble.
- Carry bag included.
- Suitable with indoor round base.
- Ideal for supermarkets, shops or indoor promotional events.

KITE	QTY	N.W	G.W	C.B.M	SIZE
Packing	1	0.85kg	1.0kg	0.0087	145x60x1000mm
	13.626	Graphic: 495x1300mm		Safe: 455x1260mm	<b>44.60 €</b>

## INDOOR ROUND BASE





2.5mm thickness  
anti-scratch finish

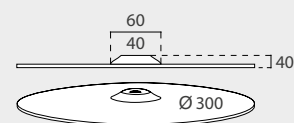

### INFORMATION

- Made of metal.
- Sided zipped black nylon carry bag with hand-strap included.
- Anti-Scratch finished.



I.ROUND BASE	QTY	N.W	G.W	C.B.M	SIZE
Packing	1	1.10kg	1.20kg	0.00198	315x20x315mm
	13.627	Diameter: Ø 300mm			<b>16.80 €</b>