

Panel Banner Vidago

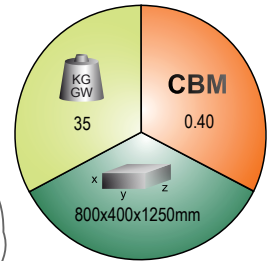

Germany Magnetisches Panel-System. Mit geraden Rahmen, um die Grafikpanel mittels Magnete-Streifen zu befestigen.

- 2 Stahl-Rundsockel.
- 2 Alu-Stangen.
- 4 Aluminiumgehäuse (700x1000mm).
- 2 Leuchten.
- 8 PS-Panel.
- Connectors.

UK Magnetic Panel System. Using straight frames to which the graphic panel can be attached by means of magnetic strips.

- 2 round steel base.
- 2 aluminum poles.
- 4 aluminum cases (700x1000mm).
- 2 spotlights.
- 8 pieces of PS of panel.
- Connectors.

France Système de panneaux magnétiques. Affichage fixé sur cadre avec ruban magnétique.

- 2 bases rondes en acier.
- 2 poteaux en aluminium.
- 4 cadres en aluminium (700x1000mm).
- 2 foyers d'éclairage.
- 8 pièces de panneau PS.
- Connecteurs.

Brazil Sistema de Painéis Magnéticos. Utilização de marcos rectos às quais os painéis gráficos se unem através de barras magnéticas.

- 2 bases redondas de aço.
- 2 postes de alumínio.
- 4 marcos de alumínio (700x1000mm).
- 2 focos.
- 8 peças de painel PS.
- Conectores.

Spain Sistema de panel magnético. Haciendo uso de marcos rectos a los cuales el panel gráfico puede unirse por bandas magnéticas.

- 2 bases redondas de acero.
- 2 postes de aluminio.
- 4 marcos de aluminio (700x1000mm).
- 2 focos.
- 8 pcs PS panel.
- Conectores.



10.430

2100x2000mm

554.00 €



Catania



 Tragbarer Wand-Aufsteller. Die Konstruktion ermöglicht ein schnelles und einfaches Aufbauen. Grafik sind nicht inklusive.

- Aluminium-Profil, Standfüße und zwei Spotlights.
- Oxford Stoffbeutel: 1 Stück.

 Portable Display Wall. The construction makes an easy and fast assembly. Printing are not included.

- Aluminium Profile, base feet and two spotlights.
- Oxford Cloth bag: 1 unit.

 Display portable, facile et rapide à monter. Visuel non inclus.

- Profils en aluminium, bases et foyers d'éclairage.
- Valise de transport Oxford Cloth: 1 unité.

 Display portátil. De fácil e rápida montagem. Material de impressão não incluída.

- Perfis de alumínio, bases e focos.
- Mala de transporte Oxford Cloth: 1 unidade.

 Display portátil de fácil y rápido montaje. Impresión no incluida.

- Perfil de aluminio, bases y dos focos.
- Maleta de transporte: 1 unidad.

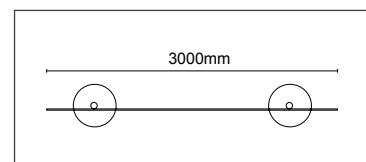
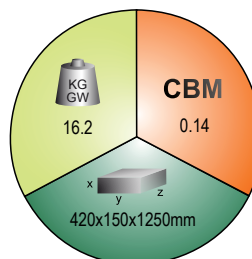

10.647

3000x2000mm

253.00 €



Perugia



Tragbarer Wand-Aufsteller. Die Konstruktion ermöglicht ein schnelles und einfaches Aufbauen. Grafik sind nicht inklusive.

- Aluminium-Profil, Standfüße und zwei Spotlights.
- Oxford Stoffbeutel: 1 Stück.

Portable Display Wall. The construction makes an easy and fast assembly. Printing are not included.

- Aluminium Profile, base feet and two spotlights.
- Oxford Cloth bag: 1 unit.

Display portable, facile et rapide à monter. Visuel non inclus.

- Profils en aluminium, bases et foyers d'éclairage.
- Valise de transport Oxford Cloth: 1 unité.

Display portátil. De fácil e rápida montagem. Material de impressão não incluída.

- Perfis de alumínio, bases e focos.
- Mala de transporte Oxford Cloth: 1 unidade.

Display portátil de fácil y rápido montaje. Impresión no incluida.

- Perfil de aluminio, bases y dos focos.
- Maleta de transporte: 1 unidad.

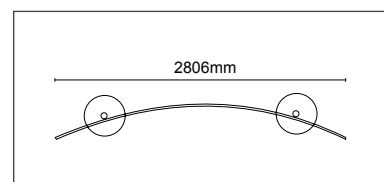
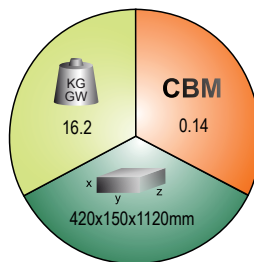

10.648

3000x2000mm

253.00 €



Limoges

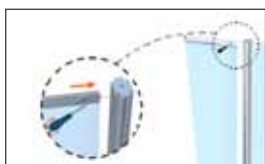

Smartes und stabiles Ausstellungssystem. Einfach zu installieren. Druck nicht inklusive.

- Aluminium-Rahmen 2000x2200mm.
- Dach-Regal: 1.
- Flügel (2 Stück) (L&R).
- Tisch: "V"-Form: 1.
- Spotlights (2 Stück).
- Plastiktasche.

Stable and elegant Exhibition System. Easy to be assembled. Printing is not included.

- Aluminium frame 2000x2200mm.
- Header Board. Shelves: 1.
- Wings (2 units) (L&R).
- Table en "V": 1.
- Spotlights (2 units).
- Plastic Packing Case.

Système d'exposition stable. Montage facile. Visuel non inclus.

- Cadre en aluminium 2000x2200mm.
- Plaque supérieur. Étagère: 1.
- Ailes (2 unités) (L&R).
- "V" Shape Table: 1.
- Foyers d'éclairage (2 unités)
- Valise de transport en plastique

Sistema de exibição estável. De fácil montagem. Impressão não incluída.

- Marco de alumínio 2000x2200mm.
- Placa superior. Prateleira: 1.
- Alas (2 unidades) (L&R).
- Mesa em forma de "V": 1.
- Focos (2 unidades).
- Mala de transporte em plástico.

Sistema de exhibición elegante y estable de fácil montaje. Impresión no incluida.

- Marco de aluminio 2000x2200mm.
- Placa superior. Estantes: 1.
- 2 Alas (izquierda, derecha).
- Mesa en forma de "V": 1.
- 2 focos.
- Maleta de transporte de plástico.

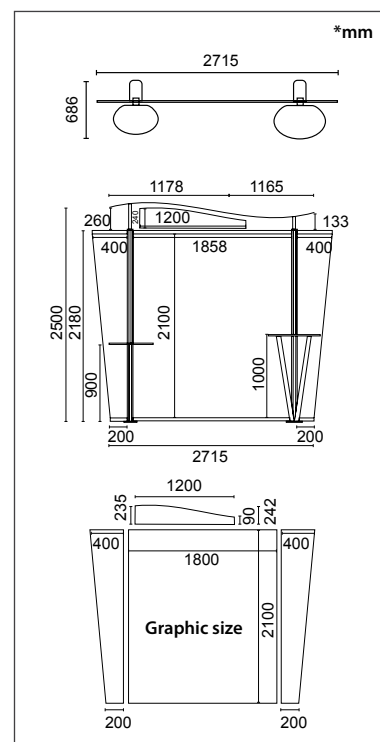
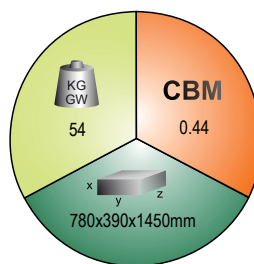

10.153

856.00 €



Opole

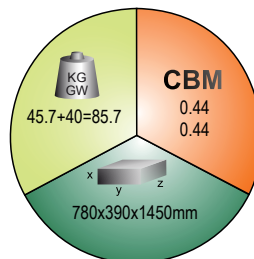
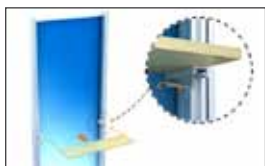
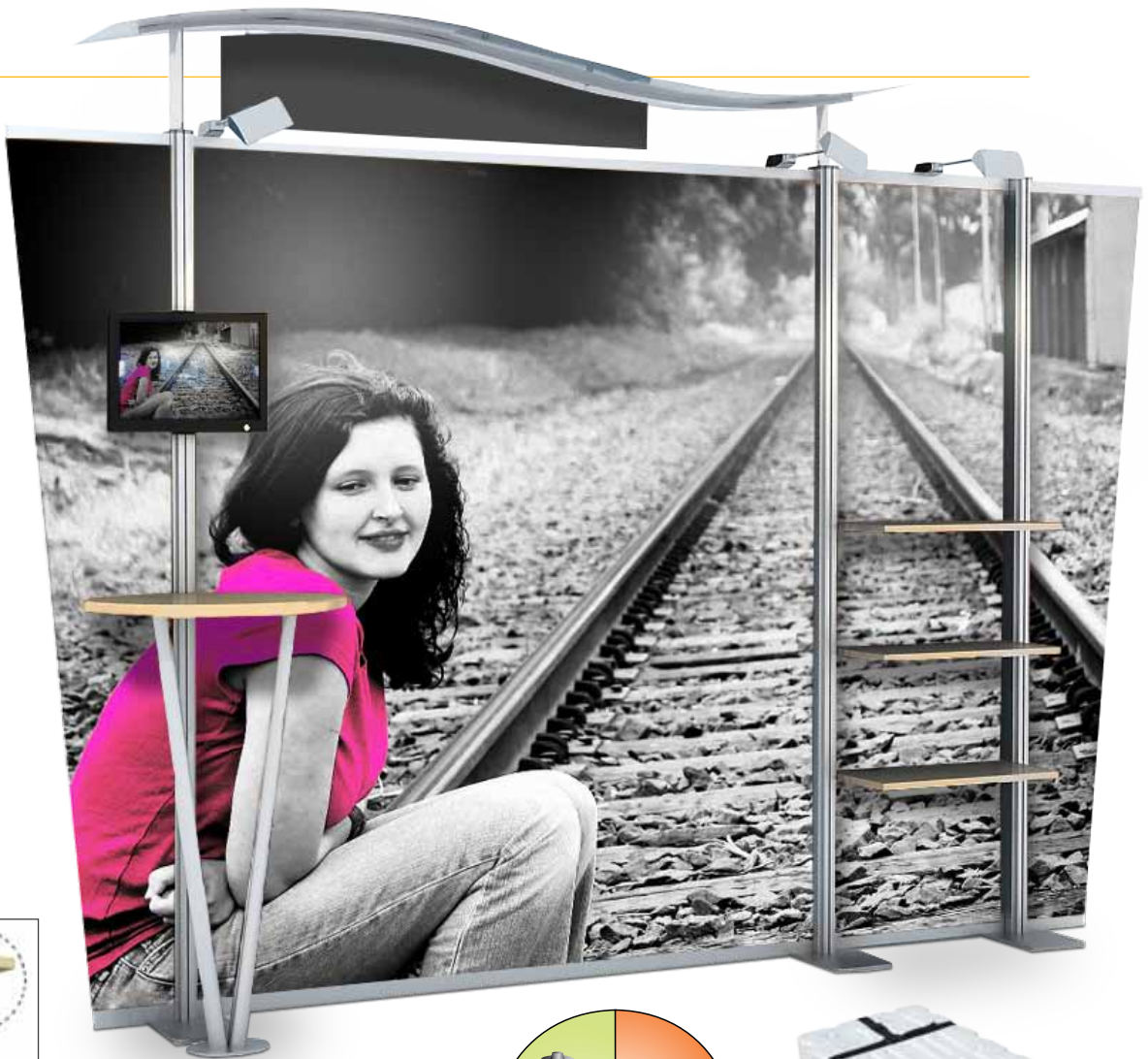

Smartes und stabiles Ausstellungssystem. Einfach zu installieren. Druck nicht inklusive.

- Aluminium-Rahmen 2850x2200mm.
- Kopfteil: 3.
- Seitenteile (2 Stück) (L&R).
- Tisch: "V"-Form: 1.
- Spotlights (3 Stück). LCD Fixierer.
- Kunststoffkoffer: 1.

Stable and elegant Exhibition System. Easy to be assembled. Printing is not included.

- Aluminium frame 2850x2200mm.
- Header Board, Shelves: 3.
- Wings (2 units) (L&R).
- "V" Shape Table: 1.
- Spotlights (3 units). LCD fixer.
- Plastic Packing Case: 1.

Système d'exposition stable. Montage facile. Visuel non inclus.

- Cadre en aluminium 2850x2200mm.
- Plaque supérieur. Étagères: 3.
- Ailes (2 unités) (L&R).
- Table en "V": 1.
- Foyers d'éclairage (3 unités).
- Valise de transport en plastique: 1 unité.

Sistema de exibição estável. De fácil montagem. Impressão não incluída.

- Marco de alumínio 2850x2200mm.
- Placa superior. Prateleiras: 3.
- Alas (2 unidades) (L&R).
- Mesa em forma de "V": 1.
- Focos (3 unidades). Fixador de LCD.
- Mala de transporte em plástico: 1.

Sistema de exhibición elegante y estable de fácil montaje. Impresión no incluida.

- Marco de aluminio 2850x2200mm.
- Placa superior. Estantes: 3.
- 2 Alas (izquierda, derecha).
- Mesa en forma de "V": 1.
- 3 focos. Fijador de LCD.
- Maleta de transporte de plástico.



*TV nicht enthalten.
TV not included.
TV non incluse.
TV não incluída.
TV no incluida.

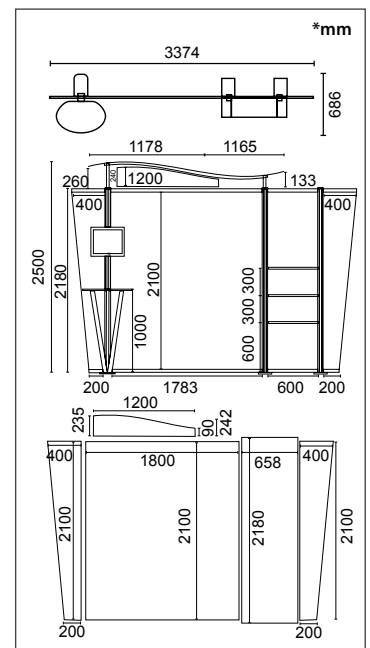



10.192

1324.00 €

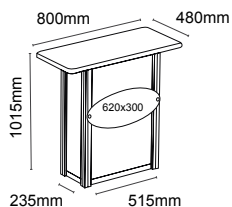

Kassel



 Smartes und stabiles Ausstellungssystem. Einfach zu installieren. Druck nicht inklusive.

- Aluminium-Rahmen 2824x2400mm.
- Dach.
- Tisch.
- Regale: 3.
- Spotlights (3 Stück).
- Plastiktasche.

 Smart and elegant Exhibition System. Easy to be assembled. Printing is not included.

- Aluminium frame 2824x2400mm.
- Header Board.
- Counter.
- Shelves: 3.
- Spotlights (3 units).
- Plastic Packing Case.

 Système d'exposition stable. Montage facile. Visuel non inclus.

- Cadre en aluminium 2824x2400mm.
- Plaque supérieur.
- Comptoir.
- Étagères: 3.
- Foyers d'éclairage (3 unités).
- Valise de transport en plastique.

 Sistema de exibição estável. De fácil montagem. Impressão não incluída.

- Marco de alumínio 2824x2400mm.
- Placa superior.
- Balcão.
- Shelves: 3.
- Focos (3 unidades).
- Mala de transporte em plástico.

 Sistema de exhibición elegante y estable de fácil montaje. Impresión no incluida.

- Marco de aluminio 2824x2400mm.
- Placa superior.
- Mostrador.
- Estantes: 3.
- 3 focos.
- Maleta de transporte de plástico.

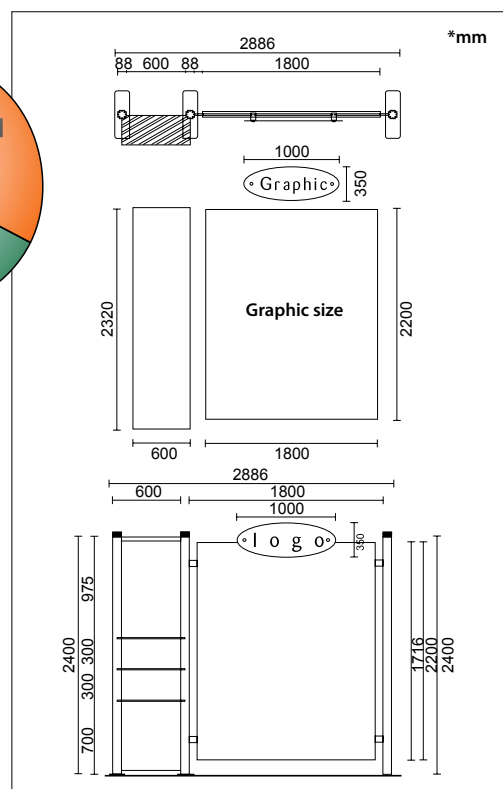
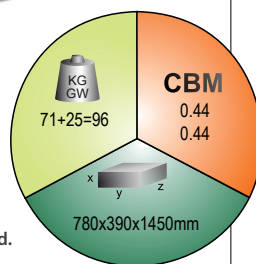

10.364

1465.00 €



Pescara

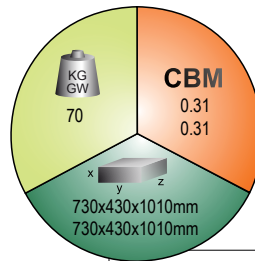
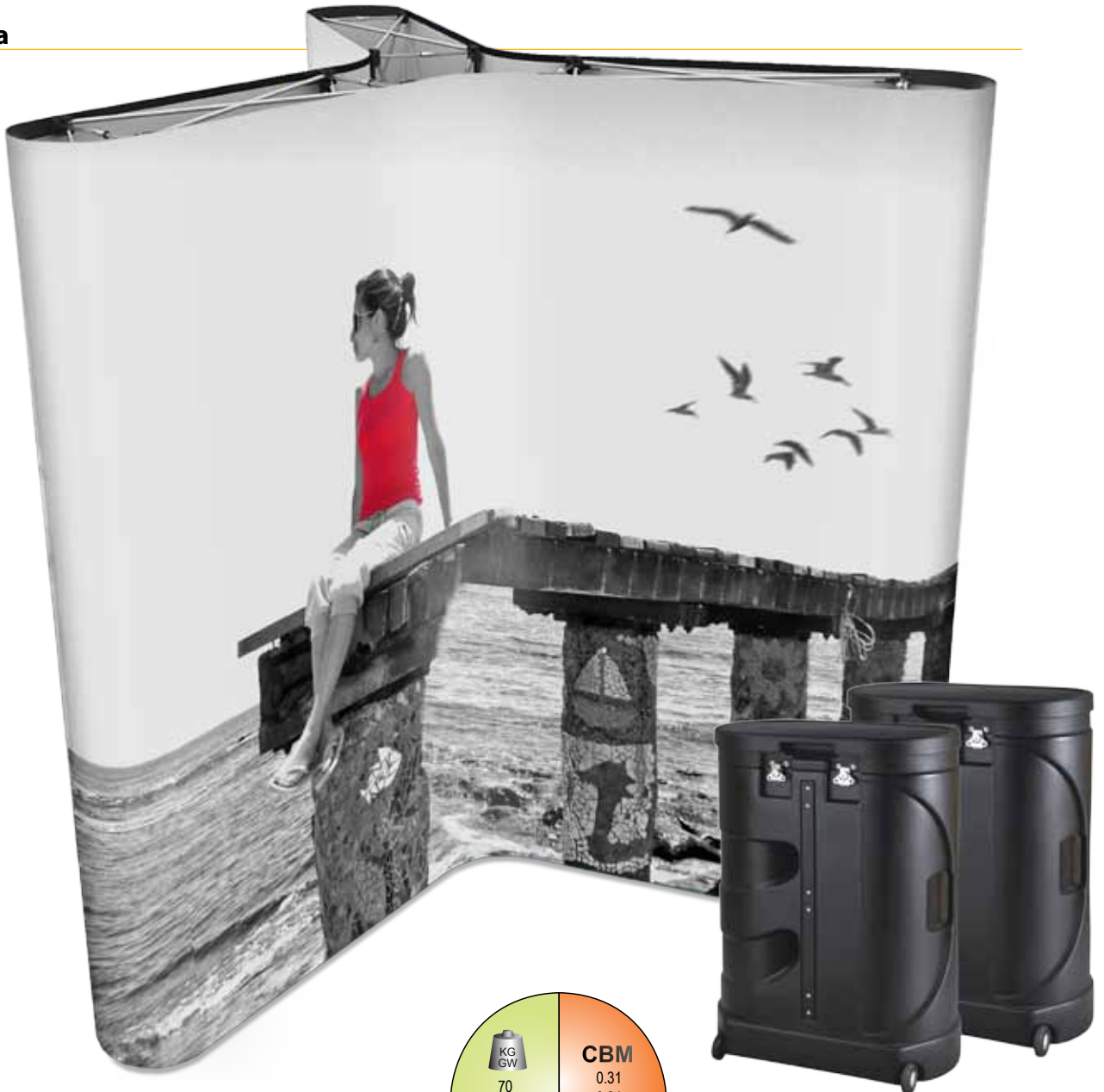

Flexibles Pop-Up-System. Einfach zu installieren. Druck nicht inklusive

- Pop-Up Rahmen 3x1 gerade x 3 sets.
- Eckverbindungen: 3 sets.
- Kunststoffkoffer: 2 Stück.

Flexible Pop-Up wall system. Easy to be assembled. Printing is not included.

- Straight Pop-Up Frame for 3x1: 3 units.
- Corner Accessories: 3 units.
- Plastic trolley Case: 2 units.

Pop-Up magnétique facile à monter. Visuel non inclus.

- Pop-Up 3x1: 3 unités.
- Accessoires pour les angles: 3 unités.
- Valise de transport en plastique: 2 unités.

Pop-Up magnético de fácil montaje. Impresión no incluida.

- Pop-Up 3x1 recto: 3 unidades.
- Accesorios das esquinas: 3 unidades.
- Mala de transporte em plástico: 2 unidades.

Sistema de Pop-Up flexible y de fácil montaje. Impresión no incluida.

- Estructura recta de Pop-Up 3x1: 3 unidades.
- Accesorios para esquinas: 3 unidades.
- 2 Maletas de plástico.

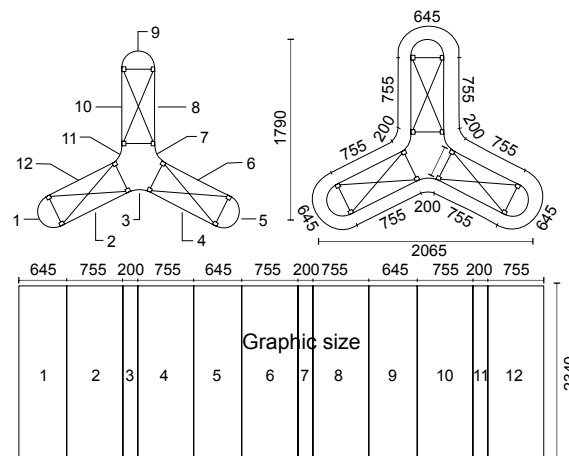

10.639

799.00 €



*mm

Florence

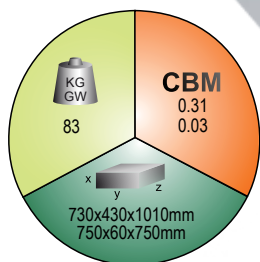

 Flexibles Pop-Up-System. Einfach zu installieren. Druck nicht inklusive.

- Pop-Up Rahmen 3x3 gerade x 1/ Pop-Up 3x2 gerade x 2 Stück.
- Eckverbindungen: 3 Stück.
- Spotlights: 2 Stück.
- Kunststoffkoffer: 2 Stück

 Flexible Pop-Up wall system. Easy to be assembled. Printing is not included.

- Straight Pop-Up Frame 3x3: 1 unit / Straight Pop-Up frame 3x2: 2 units.
- Accessories corners: 3 units.
- Spotlights: 2 units.
- Plastic trolley Case: 2 units.

 Pop-Up magnétique facile à monter. Visuel non inclus.

- Pop-Up 3x3: 1 unité. / Pop-Up 3x2: 2 unités.
- Accessoires pour les angles: 3 unités.
- Foyer d'éclairage: 2 unités.
- Valise de transport en plastique: 2 unités.

 Pop-Up magnético de fácil montagem. Impressão não incluída.

- Pop-Up 3x3 recto: 1 unid. / Pop-Up 3x2 recto: 2 unidades.
- Acessórios das esquinas: 3 unidades.
- Focos: 2 unidades.
- Mala de transporte em plástico: 2 unidades.

 Sistema de Pop-Up flexible y de fácil montaje. Impresión no incluida.

- Estructura recta de Pop Up 3x3 recto: 1 unidad / Pop-Up 3x2 recto: 2 unidad.
- Accesorios para esquinas: 3 unidades.
- Focos: 2 unidades.
- 2 Maletas de plástico.

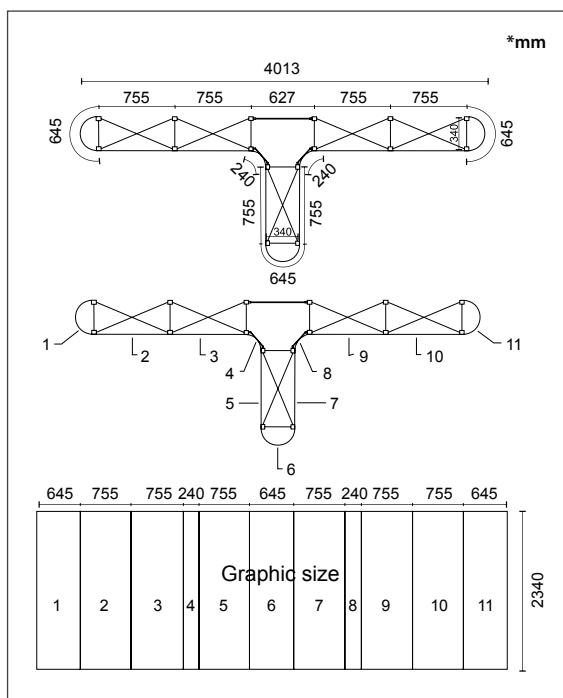
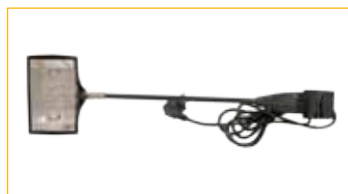

10.644

1067.00 €

